

100mm axial extract fans



Approvals:



BEAB



CE



3yr Guarantee



Zone 1



Zone 2



Suitable for a wide range of domestic applications including bathrooms, shower rooms and toilets, including zones 1 & 2.

Key features

Type: Axial extract fans

Application: Domestic bathrooms, shower rooms and toilets

Control options: Pull cord, timer, humidistat and PIR

Legislation: Conforms to Building Regulations

Hole dia: 115mm (wall) 125mm (window) 110mm (shaft/ducting)

The range

A comprehensive range of stylish, compact and easy to install single speed fans. Suitable for a wide range of domestic applications including bathrooms, shower rooms and toilets, including zones 1 & 2. Also suitable for commercial applications such as hotel bathrooms, office toilets and other small rooms.

DX100 models have a softly curved flowline grille design which will blend into wall or ceiling décor, whilst the shallow depth of the outlet spigot ensures compact window installation. All models come complete with a universal mounting kit (wall tube, gasket x2, outer grille, skirt moulding for window) suitable for wall, ceiling and window mounting (in single glazing up to 6mm) applications. The DX range includes an air operated backdraught shutter, outer grille and ducting. Control options include integral pull cord and timer; humidistat and PIR options offer automatic control.

XX100 models are supplied without a kit and are ideal for replacement applications or where a suitable outlet already exists.

All models are IPX5 rated (except **DX100PIR**) and BEAB approved, demonstrating accredited levels of safety. They are all suitable for 220-240V 50Hz mains operation, have lubricated for life motors, Class B insulation for operation in ambient temperatures up to 40°C and are fitted with a thermal cut out.

Models

DX100

Ref. 90839AW:

- Single speed axial unit
- Operated by a remote switch.

In a bathroom normally a separate pullcord or the lighting circuit

- Includes universal mounting kit
- Colour: White

DX100PC

Ref. 90840AW:

- Single speed axial unit with pullcord
- Operated by integral pullcord
- Includes universal mounting kit
- Colour: White

DX100T

Ref. 90841AW:

- Single speed axial unit with timer
- Timer triggered by a remote switch - usually the lighting circuit
- Adjustable timer (2-20mins)
- Includes universal mounting kit
- Colour: White

DX100H

Ref. 90842AW:

- Single speed axial unit with humidistat
- Automatic On/Off operation by integral humidity sensor, adjustable from 50-90% RH
- Timer function adjustable (2-20mins)
- Includes universal mounting kit
- Colour: White

DX100HP

Ref. 90843AW:

- Single speed axial unit with humidistat and pullcord
- Timer function adjustable (2-20mins)
- Automatic On/Off operation by integral humidity sensor, adjustable from 50-90% RH
- Pullcord On feature overrides the auto-humidity sensor function
- Includes universal mounting kit
- Colour: White

DX100PIR

Ref. 90844AW:

- Single speed axial unit with PIR detector
- Automatic On/Off operation
- Integral passive infrared sensor
- Includes universal mounting kit
- Colour: White

XX100

Ref. 90872AW:

- Single speed axial unit
- Operated by remote switch
- Colour: White

XX100P

Ref. 90873AW:

- Single speed axial unit with pullcord
- Operated by integral On/Off pullcord
- Colour: White

XX100T

Ref. 90874AW:

- Single speed axial unit with timer
- Normally triggered by a remote switch, for example the lighting circuit
- Colour: White

Controllers

Remote Humidistat XRH

Ref. 21856AW

- Stand alone humidistat switches fan On/Off when RH reaches pre-set levels. Complete with pullcord override switch

Time Delay Unit DT20B

Ref. 21850AW

- User adjustable run-on timer (2-20mins)

Passive Infrared Sensor XPIRA

Ref. 21871AA

- Activates fan via body movement. Ideal for infrequently used public spaces. Built in timer to prevent nuisance tripping

Technical specification

The unit is to be supplied from the Xpelair DX100 range by Applied Energy Products Ltd, Morley Way, Peterborough PE2 9JJ
Tel. +44 (0)1733 456789

Model	/	Ref
DX100		90839AW
DX100PC		90840AW
DX100T		90841AW
DX100H		90842AW
DX100HP		90843AW
DX100PIR*		90844AW

*IPX4 rated

- The unit shall be designed for wall, ceiling, shaft (or window mounting in glass up to 6mm thick) using the kit provided. An air operated backdraught shutter shall be included
- The fan housing shall be moulded in high gloss white ABS and be of modern design with finger guarding for additional safety protection
- The motor shall be lubricated for life with built in safety thermal overload protection
- The unit shall be rated at IPX5
- In addition it shall conform to Building Regulations for use in toilets and bathrooms
- Dimensions shall be W x H x D 165mm x 155mm x 43mm excluding spigot
- PC - Pullcord
- T - Timer (2 - 20mins)
- H - Humidistat control (50 - 90%RH)
- HP - Humidistat/Timer control
- PIR - Passive infrared control

Product variations

	XX100T	XX100P	XX100	DX100PIR	DX100HP	DX100H	DX100T	DX100PC	DX100
Reference number	90874AW	90873AW	90872AW	90844AW	90843AW	90842AW	90841AW	90840AW	90839AW
Remote switch (supplied separately)	yes	no	yes	no	no	no	yes	no	yes
Integral pullcord	no	yes	no	no	yes	no	no	yes	no
Integral timer (adjustable from 2-20 mins)	yes	no	no	no	no	no	yes	no	no
Humidity sensor (50-90% RH)	no	no	no	no	yes	yes	no	no	no
Passive infrared sensor	no	no	no	yes	no	no	no	no	no
Maximum air flow (m ³ /h)	76	76	76	76	76	76	76	76	76
Maximum air flow (l/s)	21	21	21	21	21	21	21	21	21
Sound pressure level dB(A)@3m	41	41	41	35	35	35	35	35	35
Electrical power rating (W)	12	12	12	12	12	12	12	12	12
Weight (kg)	0.8	0.8	0.8	1.2	1.2	1.2	1.2	1.2	1.2
IP rating	IPX5	IPX5	IPX5	IPX4	IPX5	IPX5	IPX5	IPX5	IPX5
Universal mounting kit	no	no	no	yes ₂	yes	yes	yes	yes	yes

100mm axial extract fans



Guarantee (years)	3	3	3	3	3	3	3	3	3
-------------------	---	---	---	---	---	---	---	---	---

DX100:

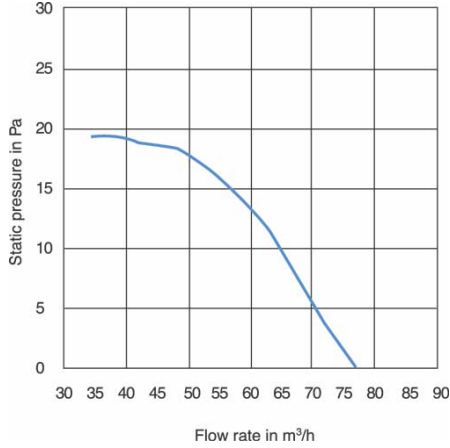

Performance:

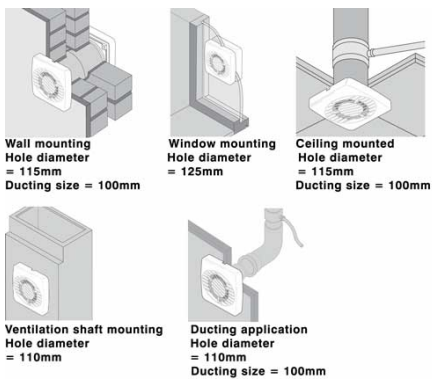

Installation:

DK100/PC/HP/PIR/XX100/P

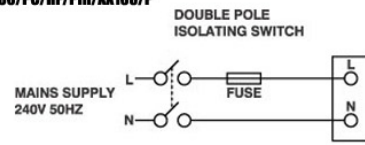

DK100T/H/XX100T

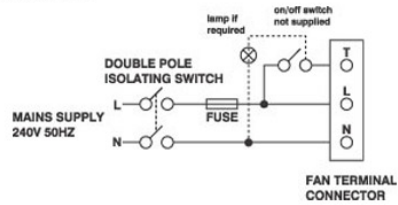

Wiring:

DX100 Range

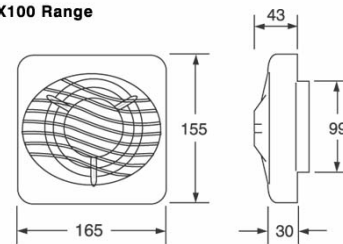

Back draught shutter

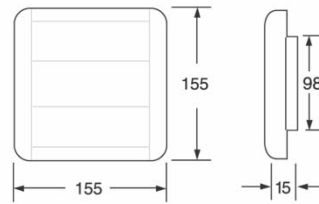

XX100

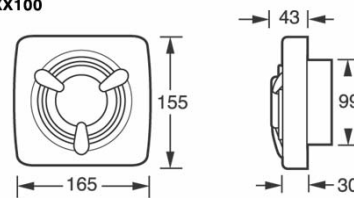

Dimensions: All dimensions in mm