

Hudson Reed

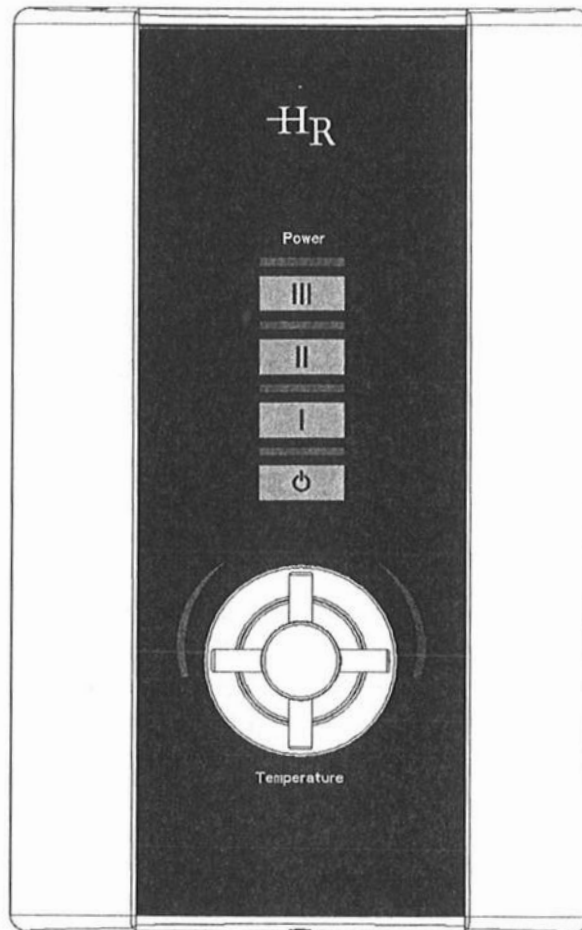

HUDSON REED AX321 & AX322

ELECTRIC SHOWER

Installation and User Guide

IMPORTANT:

**This booklet should be left with the user
after installation and demonstration**

*We offer a technical advisory service on the
telephone to contractor with problems in the field.*

RING 0870 9000 430

CONTENTS

<u>Section</u>	<u>Page</u>	<u>Section</u>	<u>Page</u>
Introduction	2	What to do if things go wrong (1)	
Important Safety Information	2	Self Help	9
How to install your AX321 / AX322 Shower .	3	What to do if things go wrong (2)	
Cold Water Inlet Pipe Configuration.	5	Professional Service	9
Assembly of Accessories	7	How your AX321 / AX322 Shower Works	10
How to maintain your AX321 / AX322 Shower	7	Hudson Reed After Sales Service	11
Additional Accessories and Common Parts . .	7	Guarantee and Contact Details	11
How to use your AX321 / AX322 Shower (Detailed)	8	How to use your AX321 / AX322 Shower (Summary)	12

INTRODUCTION

Thank you for purchasing a quality *Hudson Reed AX321 / AX322 Shower* manufactured in England. **To enjoy your new shower at its best, please take time to read this manual thoroughly to familiarise yourself with all instructions, BEFORE beginning installation.** Having done so, keep this manual handy for future reference.

Your shower is designed to stabilise temperature changes caused by water pressure fluctuations. These can result from toilets being flushed or taps being turned on and off. When this happens your showering temperature will be held within a controlled band, provided that the minimum pressure required by the shower is maintained (see "Effect of Other Water Devices").

If you experience any difficulty with the installation or operation of your new shower, then please refer to the "What to do if things go wrong" section in this manual before contacting us.

IMPORTANT SAFETY INFORMATION

1. Your shower has been designed for convenience, economy and safety of use, provided that it is installed, used and maintained in good working order and in accordance with our instructions and recommendations.
2. **All wiring and installation must be supervised by a suitably qualified person.**
3. **THIS APPLIANCE MUST BE EARTHED.**
4. The installation must be in accordance with the current edition of BS.7671 (*the "IEE Wiring Regulations"*) and "Part P" of the "*Building Regulations*" in force at the time of installation. Installations outside of England and Wales must also conform to any local regulations in effect. This appliance is intended to be permanently connected to the fixed electrical wiring of the mains supply with its own dedicated supply.
5. This appliance must **NOT** be fitted where it may be subjected to freezing conditions.
6. **DO NOT** switch the appliance on if you suspect it of being frozen. Wait until you are sure it has thawed out.
7. **DO NOT** fit any sort of tap or control on the appliance outlet. The appliance is designed to have an open outlet and should only be used with "Hudson Reed" recommended fittings.
8. Take care to avoid restricting the outlet of the pressure relief device. If water is discharged from the pressure relief device, maintenance will be required before the appliance can be safely used.
9. Isolate the mains electrical and water supply before removing the front cover of the appliance.

HOW TO INSTALL YOUR AX321 / AX322 SHOWER

WARNING: ALL WIRING AND INSTALLATION MUST BE SUPERVISED BY A SUITABLY QUALIFIED PERSON.

WARNING: DO NOT INSTALL THIS SHOWER WHERE IT MAY BE SUBJECTED TO FREEZING CONDITIONS

We recommend that the installation is done in the following sequence.

a. Fixing the shower to the wall b. Plumbing c. Electrical connections

a. FIXING THE SHOWER TO THE WALL

1. Position the riser rail at a convenient height for majority of users as detailed in Diagram 1 and mark its position.
2. Position the heater so that the top of the unit is horizontal and level with, **or a maximum of 0.6 metres (2ft) below the top of the riser rail**. Choose a flat piece of wall to avoid the possibility of distorting the backplate, as this may make the front cover a poor fit.
3. Adjust the position to get the most convenient arrangement taking the following into account.
 - **The heater must not be mounted in the direct spray from the handset.**
 - The handset must not be able to come into contact with used water in the cubicle, bath or basin. If it can, then a vacuum breaker must be fitted (available from us if required).
4. Fix the riser rail with screws provided.
The fixing holes at the base of the brackets will be disclosed by removing the plastic fronts. See Diagram 4 and instructions supplied with accessories for further details.
5. If you have not yet done so, remove the front cover assembly by undoing the retaining screws at the top and bottom of the unit and lifting the cover off.
6. Your shower unit not only accepts services from the top, bottom or rear. It also accepts services from the left or right hand side of the unit. Decide the position of the electrical cable into the unit.
If top entry is chosen, cut away the walls in the backplate as shown in Diagram 2a.

If bottom entry is chosen, cut away the walls in the detachable bottom section as shown in Diagram 2b. The detachable bottom section is secured to the backplate by 2 screws.

7. Decide the position of entry of the cold water pipe into the unit.
If top entry is chosen, cut away the backplate as shown in Diagram 2a.

If bottom entry is chosen, cut away the walls in the detachable bottom section as shown in Diagram 2b.

If rear, please read the section on plumbing. To aid installation, you may find it convenient to move the flexible pressure relief valve outlet assembly by removing the two securing screws. If you do, please ensure that they are fully tightened on re-assembly (see Diagram 2b).

Diagram 1

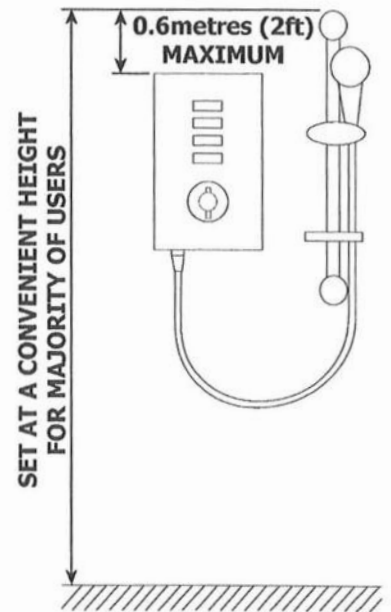
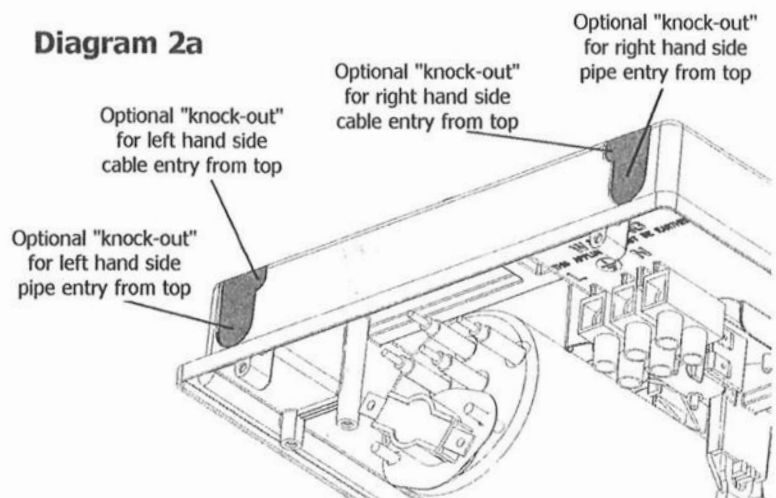

Diagram 2a



8. Your shower is provided with 3 fixing positions in the backplate (see Diagram 6). The top-fixing hole is a "key-hole" slot, and should be marked and drilled first.

Tighten top screw with head protruding about 10mm from the wall and hook the backplate over the screw head. This allows for correct and accurate alignment of your shower before marking and fixing the bottom positions.

You may not wish to tighten up both screws at this stage as the holes are elongated to allow for adjustment after other connections have taken place.

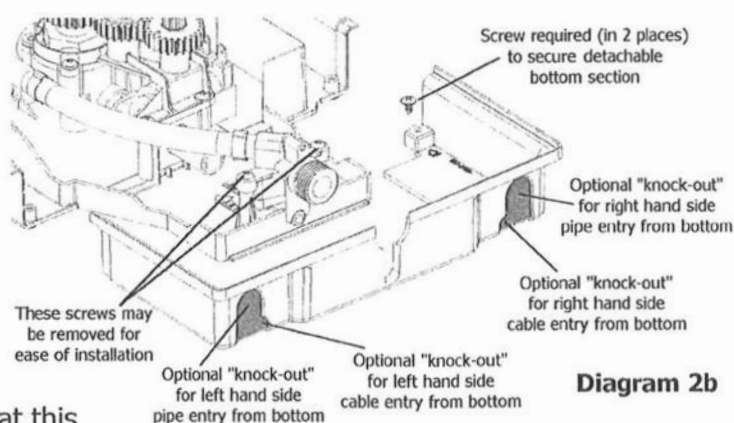

Diagram 2b

- b. **PLUMBING** (For your convenience a cold water inlet configuration diagram is shown on page 5)

WARNING: ENSURE THAT THE MAINS WATER SUPPLY MEETS THE REQUIREMENTS BELOW BEFORE CONTINUING WITH INSTALLATION.

The heater must be connected to the mains cold water supply. This must have a minimum running pressure of 69kPa (0.7 bar, 10 psi) and a maximum pressure of 690kPa (7.0 bar, 100 psi).

WARNING: BEFORE CONNECTING THE PIPE WORK TO THE SHOWER, ENSURE THAT THE PIPE WORK IS FULLY FLUSHED OUT.

1. Unscrew the "Red Cap" from the shower outlet pipe and discard it in a suitable manner. It has been used to seal the shower during transit, and is no longer required.
2. It is recommended that a WRAS (Water Regulations Advisory Scheme) listed isolating valve is fitted to the incoming mains cold water before the shower unit. This will allow the unit to be serviced or exchanged without having to turn off the mains water at the water stop valve.
3. The heater can be fed from a header tank provided this has a minimum head of 7 metres (23ft).
4. The cold water inlet connection supplied is a plain Ø15mm straight shank/shaft. This connector will accept either a Ø15mm compression elbow or a Ø15mm "push-on elbow". Ø15mm copper, stainless steel or suitable plastic pipe should be used. For your convenience, a cold water inlet configuration diagram is shown on page 5. If rear entry is required, treat as topentry with an additional "Yorkshire" elbow (soldered type) for fitting into the rear channel. To aid installation, you may find it convenient to move the flexible pressure relief valve outlet assembly by removing the two securing screws (See Diagram 2b). In multiple installations, correct pipe work sizes should be calculated to maintain adequate flow to each shower.
5. It is permissible to use a WRAS (Water Regulations Advisory Scheme) approved sealant sparingly whilst avoiding excess finding its way into the shower operating parts.
6. With isolating valve connected, **flush the pipe work through to remove any particles etc**, before making the final connection to the shower. Blockage in the water ways (particularly the handset and solenoid valve) will prevent the heater working properly. *Note: You may be charged for a service call if it is due to incorrect installation.*
7. The shower is designed to have an open outlet and should only be used with "Hudson Reed" recommended fittings. Do not connect the handset until after the front cover and detachable bottom section are fitted.

WARNING: DO NOT FIT A TAP ON THE SHOWER OUTLET.

WARNING: TAKE CARE TO AVOID RESTRICTING THE OUTLET OF THE PRESSURE RELIEF VALVE.

COLD WATER INLET PIPE CONFIGURATION

Please note that standard compression fittings are shown.
Push-Fit connections or a combination of the two are also suitable.

To aid installation, you may find it convenient to move the flexible pressure relief valve outlet assembly by removing the two securing screws.

If you do, please ensure that they are fully tightened on re-assembly (see Diagram 2b).

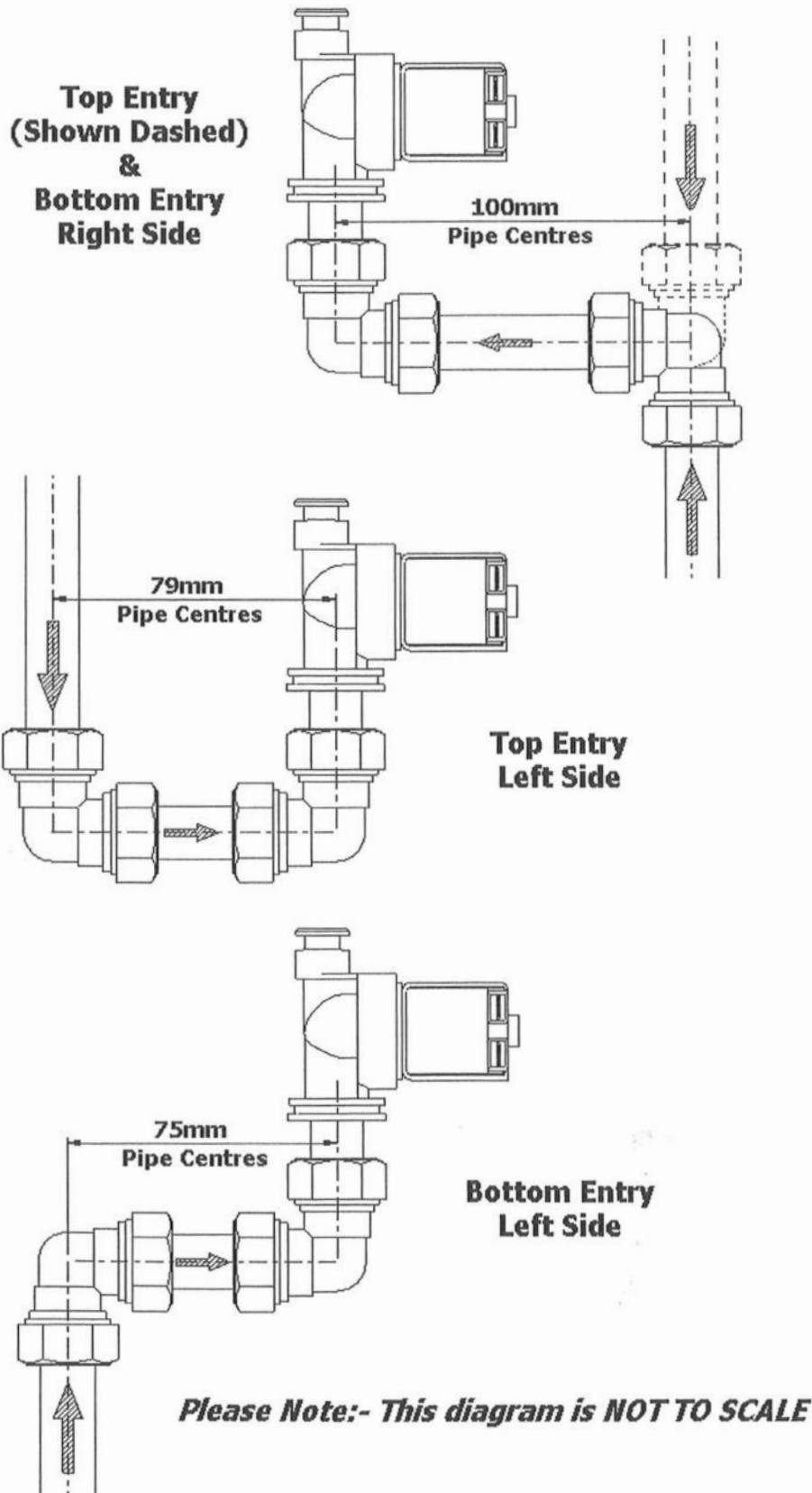

c) ELECTRICAL

WARNING: THIS SHOWER MUST BE EARTHED.

The electrical installation must be in accordance with the current BS.7671 (IEE Wiring Regulations) and "Part P" of the Building Regulations and/or local regulations.

- The shower unit is designed for a single phase AC electrical supply.
Please check the rating plate on the unit to see what details apply to your shower.
AS A GUIDE ONLY (Only applies if external earth impedance is less than 0.35 Ohms)*

Rating	Cable Sizes	Fuse / MCB	Cable Length
8.5 / 7.8kW 240 / 230V	6.0mm ² 10.0mm ²	40A Type B MCB	27m Max. 45m Max.
	6.0mm ² 10.0mm ²	45A BS.1361 fuse	12m Max.* 21m Max.*
9.5 / 8.7kW 240 / 230V	6.0mm ² 10.0mm ²	40A Type B MCB	27m Max. 45m Max.
	6.0mm ² 10.0mm ²	45A BS.1361 fuse	12m Max.* 21m Max.*
10.5 / 9.6kW 240 / 230V	10.0mm ²	45A BS.1361 fuse	12m Max.*

Remember to upgrade the cable if it runs in thermal insulation in a loft, or for a longer distance.

- A means for disconnection in all poles must be incorporated in the fixed wiring in accordance with the wiring rules. We recommend a ceiling switch mounted in a convenient position.
- If you have decided to connect the cable on the left hand side then please remove and use the cable clamp that was provided along the right side (see Diagram 3a/b).

WARNING: IF LEFT HAND SIDE CABLE ENTRY IS USED, THE MAINS CABLE OUTER SHEATH MUST BE STRIPPED BACK TO THE LEVEL MARKED ON THE BACKPLATE, AND ALL THREE CONDUCTORS MUST BE FULLY SLEEVED WITH THE SLEEVING PROVIDED BETWEEN THERE AND THE TERMINAL BLOCK (SEE DIAGRAM 3a).

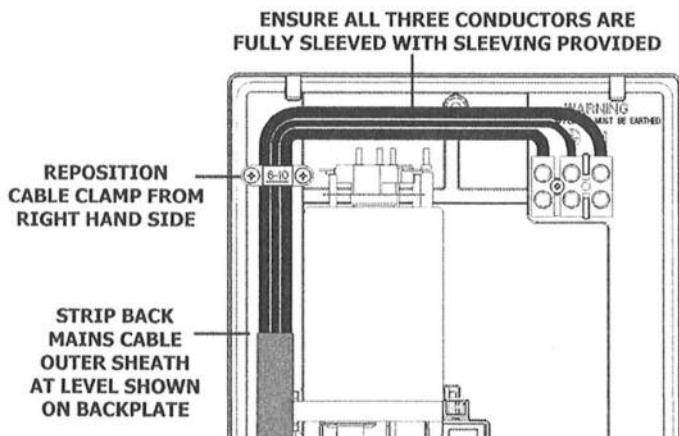

Diagram 3a
Left Side Installation

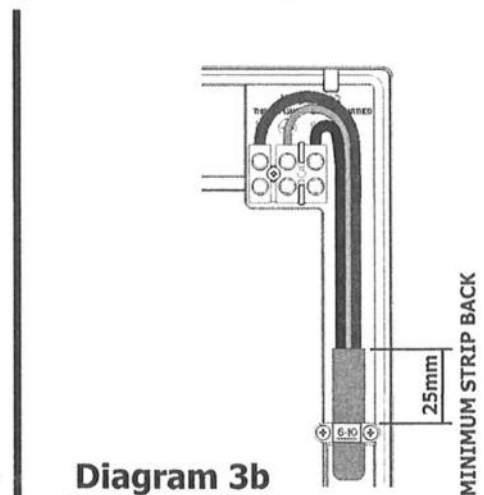

Diagram 3b
Right Side Installation

PLEASE NOTE: THE SLEEVING PROVIDED IS REQUIRED FOR LEFT HAND SIDE CABLE ENTRY ONLY. IT IS NOT REQUIRED FOR RIGHT HAND SIDE ENTRY.

- Connect cable to terminal block making sure that all the retaining screws are **VERY TIGHT** and that no cable insulation is trapped under the screws.

WARNING: FAILURE TO COMPLY WITH THESE INSTRUCTIONS COULD RESULT IN FAILURE OF THE TERMINAL BLOCK.

- Re-fit the detachable bottom section with the two screws if it was removed.

IMPORTANT: Ensure you connect the flying lead from PCB to the front cover.

- Re-fit the front cover, and secure by replacing the top and bottom fastening screws.

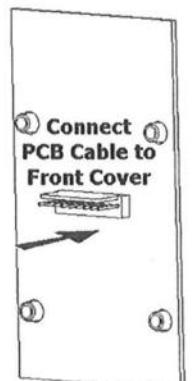

7. Fit the shower hose, and operate the shower first without the handset to flush out particles, fit the handset and then operate the shower as on page 8 or 12 and check:
 - Water gets to a satisfactory temperature and water flow can be adjusted by control knob "E".
 - Knob "E" has been correctly engaged by ensuring that the knob turns approximately one full turn.
 - Power selection operates in all 3 button settings, giving a change in water temperature.
 - Check again for leaks and that the holes in the shower handset are not blocked.
8. **Demonstrate the showers operation to all users.**

ASSEMBLY OF ACCESSORIES

Diagram 4 (Riser Rail and Soap-Dish Fitting Instructions)

(Refer to the separate fitting instruction sheet packed with the accessories for more details)

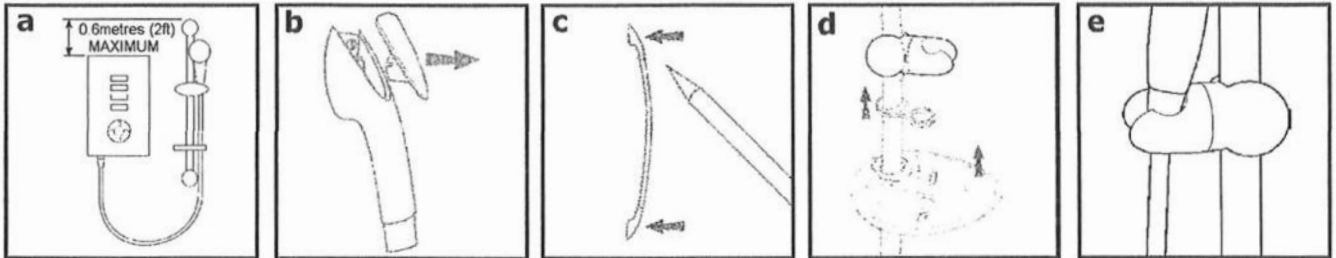

1. Establish height of riser rail to suit user requirements. This should be a maximum of 0.6 metres (2ft) above the level of the heater, see (a) and Diagram 1.
 2. Remove covers from the wall brackets (b).
 3. Hold the rail assembly in the selected position against the wall, ensure that the brackets are vertically aligned, and mark the wall for upper and lower screw fixings (c).
 4. Drill and plug the wall.
 5. Remove lower bracket from the rail and fit the adjustable slider, hose-retaining ring and soap dish onto the rail (d).
 6. Replace the lower bracket and fix the assembly to the wall.
 7. Replace the covers onto both brackets.
- NOTE: The adjustable slider grips the conical nut on the shower hose (e).

HOW TO MAINTAIN YOUR AX321 / AX322 SHOWER

It is recommended that the shower unit and hose etc. be cleaned using a soft cloth and that the use of abrasive or solvent based cleaning fluid be avoided, especially on any plated finishes. We recommend that before any cleaning, the isolating switch be turned off, thus avoiding accidentally switching on the shower.

WARNING: YOU MUST REGULARLY INSPECT THE SHOWER HOSE FOR WEAR AND DAMAGE. REPLACE IF NECESSARY, OR EVERY TWO YEARS, WITH AN APPROVED PART.

WARNING: IN ORDER TO MAINTAIN THE PERFORMANCE OF YOUR SHOWER, YOU MUST REGULARLY CLEAN THE SHOWER HANDSET.

All water contains particles of lime-scale, which build up in the shower handset and unit reducing the performance.

It is therefore important to clean the shower handset by simply rubbing the rubber nozzles, or soaking in proprietary lime-scale remover and rinsing thoroughly before use.

NOTE: After use it is normal for some water to drip from the shower handset for a few moments. This inhibits lime-scale build-up over prolonged use.

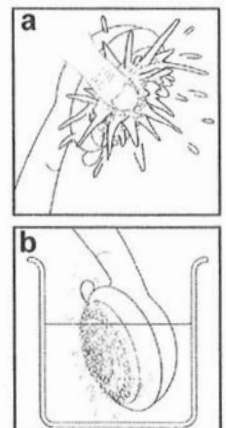

ADDITIONAL ACCESSORIES

COMMON SPARE PARTS

Please Note:- The fitting of Spare Parts must be supervised by a suitably qualified person.

WRAS Listed Water		Front Cover without PCB	Cat No. 93550822
Isolating Valve	Cat No. 93792452	Front Cover complete with PCB	Cat No. 93550823
Curtain and Rail Pack	Cat No. 83792812	Thermal Cut-Out 50/88°C	Cat No. 93597871
<i>A more comprehensive list of additional accessories and spare parts can be supplied from the Hudson Reed Sales Hotline 0870 9000 420</i>		Solenoid Valve	Cat No. 93590355
		1.25m long Chrome Shower Hose	Cat No. 93797641

HOW TO USE YOUR AX321 / AX322 SHOWER (DETAILED)

1. Ensure the electricity and water are turned on to the unit. **Diagram 5**
2. Your shower can be turned on by pressing either **Button "A", Button "B" or Button "C"** (see Diagram 5).

Button "A" (III) - Starts shower on "**High**" power.

Button "B" (II) - Starts shower on "**Medium**" power.

Button "C" (I) - Starts shower on "**Cold**".

Once pressed, a light will illuminate above the button confirming that power selection has been made.

Knob "E" controls the temperature of the water, and **For this example turn Knob "E" to "mid-position"**.

3. **Press Button "A"** and the water will flow.
4. Allow about 20 seconds for the temperature of the water to stabilise. It is recommended that you do not wholly enter the water spray during this period, even if the shower has just been used.

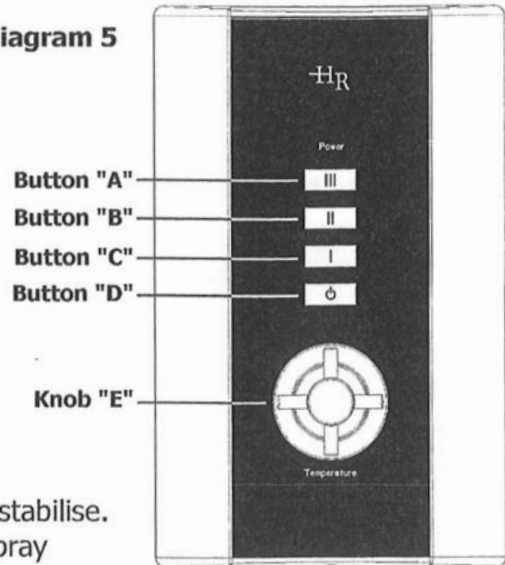

IF WATER IS TOO COLD

Turn Knob "E" anti-clockwise "1/8" of a turn, and continue turning anti-clockwise until you get the water temperature of your liking.

Wait 20 seconds after each adjustment for the water temperature to stabilise.

The final adjustment may be in any position.

If after turning fully anti-clockwise water is still too cold, set shower pattern on shower handset to outer or inner pattern only.

IF WATER IS TOO HOT

Turn Knob "E" clockwise "1/8" of a turn, and continue turning clockwise until you get the water temperature of your liking.

Wait 20 seconds after each adjustment for the water temperature to stabilise.

The final adjustment may be in any position.

If after turning fully clockwise, water is still too hot, press Button "B" (II - medium) and re-adjust Knob "E" to give desired temperature.

Water flow will be reduced on this setting.

5. Once a temperature setting to your liking has been achieved, Knob "E" will rarely need adjusting. You must however take into account required adjustments for variations of incoming mains water temperature between summer and winter (see "Effect of Seasonal Incoming Water Temperature Changes" page 10).
6. When you have **finished** showering, **press button "D"** (⏻) only, the LED light above will flash. **Water will continue to flow for up to 7 seconds before switching off.** Wait for the water to stop, and then switch off the electricity at the ceiling switch or local isolator.
7. Turning the shower on by pressing **Button "B"** reduces the power used by the shower giving a cooler shower or the option of reduced water flow. This option is mainly for summer usage and if this is used then **Knob "E"** must be re-adjusted.
8. Turning the shower on by pressing **Button "C"** will supply water without any heating.
9. Your shower is **designed to stabilise temperature** changes caused by water pressure fluctuations (see "Effect of Other Water Devices on Incoming Water Supply" see page 10).

WARNING: DO NOT SWITCH THE SHOWER ON IF YOU SUSPECT IT OF BEING FROZEN. WAIT UNTIL YOU ARE SURE IT HAS THAWED OUT.

WARNING: DO NOT OPERATE THE SHOWER IF WATER IS DISCHARGED FROM THE PRESSURE RELIEF VALVE. MAINTENANCE IS REQUIRED BEFORE THE SHOWER CAN BE SAFELY USED.

WARNING: CONSIDERATION SHOULD BE GIVEN TO SUPERVISING THE YOUNG, ELDERLY AND THE INFIRM WHILST THEY USE THIS SHOWER.

WHAT TO DO IF THINGS GO WRONG (1)

SELF HELP

If the shower is not working satisfactorily, make the following checks before calling out the installer. Any one of these adjustments could restore the performance.

The shower cycles from HOT to COLD	Temperature is set too hot causing the thermal cut-out (safety device) to operate. Turn knob "E" clockwise to increase water flow. Slowly increase the water temperature by turning knob "E" anti-clockwise until a comfortable showering temperature has been reached. WAIT approximately 20 seconds for each adjustment to affect the water temperature. "II (Medium)" setting may need to be selected.
Water too HOT	Increase water flow by adjusting knob "E" clockwise. "II (Medium)" setting may need to be selected. Increase pressure to water supply e.g. fully open service valve or stop cock. Check hose is not kinked restricting the water flow and clean handset.
Water too COLD	Check power is on by LED indicator being illuminated. Decrease water flow by adjusting knob "E" anti-clockwise. "III (High)" setting may need to be selected. Select inner or outer only handset spray pattern.
Spray pattern poor	Clean the shower handset.
Water takes longer to heat up	Thermal cut-out has operated after previous use and the LED indicator has gone out (automatically resets when unit cools down). "III (High)" setting may need to be selected.
Water goes cold while using shower	Check LED indicator is illuminated. Check water pressure has not fallen so far as to let pressure switch cut out, e.g. Another tap drawing water off. Raise position of shower handset.
Broken parts	Please contact our spares department on 0870 9000 420 (UK only).
Water continues to flow when button "D" pressed to stop	This is normal. The shower includes a shutdown feature that means the water will continue to flow for up to 7 seconds after "D (stop)" has been selected.

WHAT TO DO IF THINGS GO WRONG (2)

PROFESSIONAL SERVICE

If the previous "Self Help" checks fail to restore the performance, you should seek professional help.

The person who installed the shower is probably the best one to investigate and correct it and is certainly the person to contact if you have had a problem in the guarantee period.

The following additional checklist is provided for the benefit of the qualified service person.

WARNING: SWITCH OFF THE ELECTRICITY AT THE LOCAL ISOLATOR BEFORE REMOVING THE COVER TO MAKE CHECKS

Water too HOT	Water flow restricted by blockage in filter of solenoid valve. Replace solenoid valve.
Water too COLD	Check circuit through thermal cut-out and/or through pressure switch microswitches. A schematic wiring diagram is available from our technical advisory service. Check each element circuit and check tightness of electrical connections.
No control over water flow	Check control knob is correctly engaged onto the stabiliser valve drive gear. Undo headworks of stabiliser valve. Check stabiliser is in place and remove any debris in valve then re-assemble.
Water discharges from pressure relief valve	Check for cause of high pressure and remove it. Blockage on outlet e.g. blocked shower handset. Replace the pressure relief disc (not covered by guarantee).
Water does not flow when button "A B C" is pressed.	Ensure that the flying lead from the PCB is connected to the Front Cover. Check circuit through solenoid coil and/or through pressure switch microswitches. Possible PCB fault. If defective then replace. Power supply not reaching shower.

HOW YOUR AX321 / AX322 SHOWER WORKS

1. Water is heated instantaneously as it flows over the heating elements in the copper cylinder (Diagram 6).
2. The heaters are only switched on when sufficient water is flowing. This is done automatically with a switch which works on water pressure and is indicated by the LED indicator illuminating.
3. The water is turned on and off by the solenoid valve and Control PCB built into the shower. This is switched on when button "A", "B" or "C" is pressed.
4. The flow of water is automatically held at the level set by the user even though the supply pressure may vary (see "Effect of Other Water Devices on Incoming Water Supply").

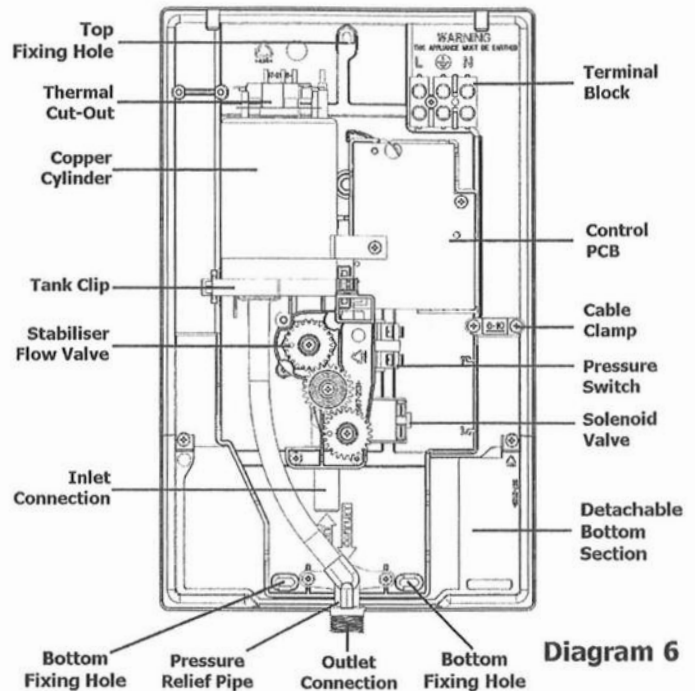

Diagram 6

5. If the water supply falls below a set limit, the pressure switch will operate and switch off the power to the elements. This is indicated by LED indicator going out (see "Effect of Other Water Devices on Incoming Water Supply").
6. **As a further safeguard**, a thermal cut-out switches the power off if the water temperature climbs above the set limit. This cut-out, which gives an audible click, may also operate due to residual heat when the shower is switched off. It will reset itself if water is run through the shower for 10 to 20 seconds.
7. The pressure relief device is to safeguard against abnormal pressure conditions, and provides a level of appliance protection should an excessive build of pressure occur within the shower.

Effect of Seasonal Incoming Water Temperature Changes

The required water temperature is achieved by adjusting the rate of water flow. Diagram 7 shows the principle involved in relating temperature rise to flow rate. The higher the water rate the lower the temperature and vice versa. The temperature of the water supplied from the mains can vary considerably throughout the year from 5 to 20°C.

This means that in the winter, flow rate will be less than in the summer to achieve the same outlet temperature.

In summer the "II (Medium)" power setting may give adequate hot water.

In some **winter** conditions, it may be necessary to select the **inner or outer spray pattern** only of your shower handset. This will ensure correct operation of the shower with a slightly lower flow rate.

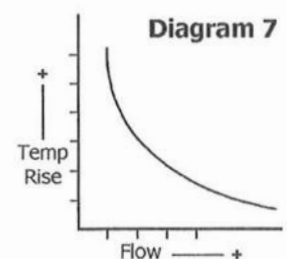

Diagram 7

Effect of Other Water Devices on Incoming Water Supply

Your shower is **designed to stabilise temperature** changes caused by water pressure fluctuations. These can result from toilets being flushed or taps being turned on and off. When this happens your showering temperature will be held within a controlled band, provided that the minimum pressure required by the shower is maintained.

Your shower requires a minimum running pressure of 69kPa (0.7 bar, 10 psi).

At pressures above 69kPa (0.7 bar, 10 psi) it will minimise temperature fluctuations as detailed above. If the water pressure falls below 69kPa (0.7 bar, 10 psi) it is likely that the pressure switch will turn off the power to the heating elements, resulting in a cold shower.

HUDSON REED AFTER SALES SERVICE

We offer a technical advisory service on the telephone to installers and other customers with problems in the field. **RING 0870 9000 430 (UK ONLY)**

Remember to quote the exact type of shower, as written on the shower front and on its leaflet. The model and serial number are located on the bottom face of the shower.

Make a note of those numbers here, and be sure to quote them if you call for advice.

Model Number: 53-67_____ / **Serial Number:** _____

Note: You may be charged for a service call if you do not have the serial number.

GUARANTEE AND CONTACT DETAILS

GUARANTEE

We, Ultra Finishings Limited, guarantee this product **for domestic use only**, for the period of 24 months from date of purchase.

Within the guarantee period we will resolve, **free of charge**, any manufacturing defects in the product resulting from faulty workmanship or material on the condition that:-

- a) The appliance has been correctly installed in accordance with our instructions and is being used on the supply circuit or voltage printed on the rating plate.
- b) The appliance has been used in accordance with these instructions and has not been tampered with or otherwise subject, neglect or accident.
- c) The appliance has not been taken apart, modified or repaired except by a person authorised by us.
- d) Evidence of the date of purchase in the form of an invoice or receipt will be required in order to qualify for an in-guarantee repair.
- e) The guarantee period for the products used in commercial applications will be limited to 12 months.
- f) For the service work to be undertaken free of charge, the work must only be undertaken by Ultra Finishings Limited, or our approved agents.
- g) Service under guarantee has no effect on the expiry date. The guarantee of any exchanged parts or product ends when the original guarantee period ends.

EXCLUSIONS

This guarantee **DOES NOT** cover damage or defects arising from poor or incorrect installation, improper use or lack of maintenance, including build-up of limescale. It is the responsibility of the installer to check that the installation parameters meet the requirements of the product, and any relevant regulations.

If we are called out to a fault, which is subsequently identified as being an installation fault, we will make a charge. It is important that the routine checks are completed before calling us out, as many issues can be simply diagnosed and resolved.

We make no guarantees as to response times for repairs. We will endeavour to achieve the most timely response possible but while we indicate an average response time, this should not be taken as a guarantee.

The guarantee applies to a repair or replacement (at our discretion) of the product subject to the conditions above, and **DOES NOT** cover compensation for the loss of the product or consequential loss of any kind.

The guarantee does not apply to the repair or replacement of pressure relief devices, sprayheads, hoses, accessories, isolating switches, electrical cable, fuses and/or circuit breakers.

This guarantee does not affect your statutory rights.

Hudson Reed
ULTRA FINISHING LIMITED

WIDOW HILL ROAD, HEASANDFORD INDUSTRIAL ESTATE, BURNLEY, LANCS, BB10 2BE

TEL: 01282 436934 / FAX: 01282 428915

Technical Advice Line: 0870 9000 430

Website: www.ultra-group.co.uk

HOW TO USE YOUR AX321 / AX322 SHOWER (SUMMARY)

1. Ensure the electricity and water are turned on to the unit.
2. Your shower can be turned on by pressing either **Button "A", Button "B" or Button "C"**

Button "A" (III) - Starts shower on "**High**" power.

Button "B" (II) - Starts shower on "**Medium**" power.

Button "C" (I) - Starts shower on "**Cold**".

Press **Button "A", "B" or "C"**.

Water will flow and the LED indicator above your choice will illuminate. It is recommended that you do not wholly enter the water flow during this period.

3. If the water is not at your **desired** showering temperature, turn **knob "E" a small amount** until you reach the desired showering temperature.

Turn clockwise for cooler or Turn anti-clockwise for warmer.

4. When you have finished showering, **press Button "D" (⏻)** only, the LED light above will flash. **Water will continue to flow for up to 7 seconds before switching off.**
5. Switch off the electricity supply at the ceiling switch or local isolator.

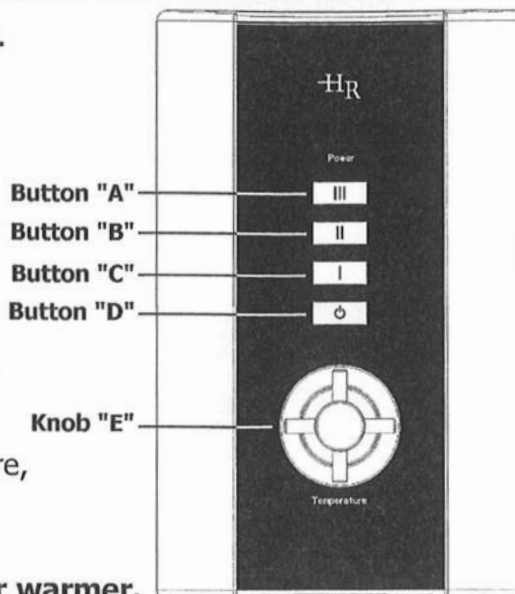

Notes

- *Wait 20 seconds for the temperature to stabilise after each adjustment.*
- *The LED indicator light illuminates when the heaters are on and, if the shower has been recently used, can take up to 20 seconds to come on. During this time the water may go from very hot to cold before stabilising.*
- *The position of knob "E" will be approximately the same each time the shower is used, varying only with incoming water temperature or pressure changes (e.g. you will only need to change from summer to winter).*
- *During normal operation, if an overheated water temperature is sensed then the heater will switch off and the LED indicator light will go out. Water will continue to flow and cool down before the heater switches back on again.*

IMPORTANT WARNINGS!

**DO NOT SWITCH THE APPLIANCE ON IF YOU SUSPECT IT OF BEING FROZEN.
WAIT UNTIL YOU ARE SURE IT HAS THAWED OUT.**

DO NOT OPERATE THE APPLIANCE IF WATER DISCHARGES FROM THE PRESSURE RELIEF VALVE. MAINTENANCE IS REQUIRED BEFORE THE APPLIANCE CAN BE SAFELY USED.

THIS APPLIANCE IS NOT INTENDED FOR USE BY PERSONS (INCLUDING CHILDREN AND THE INFIRM) WITH REDUCED PHYSICAL, SENSORY OR MENTAL CAPABILITIES, OR LACK OF EXPERIENCE AND KNOWLEDGE, UNLESS THEY HAVE BEEN GIVEN SUPERVISION OR INSTRUCTION CONCERNING USE OF THE APPLIANCE BY A PERSON RESPONSIBLE FOR THEIR SAFETY.

**CHILDREN SHOULD BE SUPERVISED TO ENSURE THAT THEY
DO NOT PLAY WITH THE APPLIANCE.**

We offer a technical advisory service on the telephone to installers and other customers with problems in the field. RING 0870 9000 430 (UK ONLY)

